

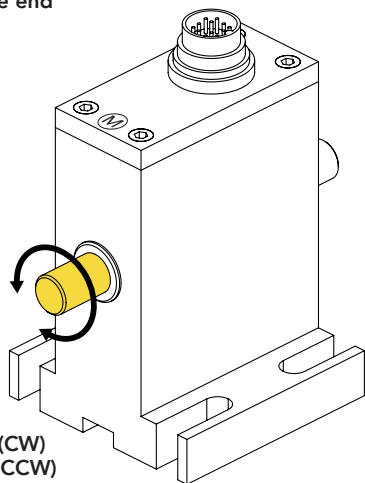

FEATURES

- Utilizes strain gauge technology
- Angle speed feedback included
- Compact size
- Can operate up to 7000 RPM

Active end



+ Output (CW)
- Output (CCW)

M = Measuring Side

SPECIFICATIONS

PERFORMANCE

Nonlinearity	±0.2% of RO
Hysteresis	±0.1% of RO
Nonrepeatability	±0.2% of RO
Rotational Speed	7000 Max

ELECTRICAL

Bandwidth	3 kHz
Typical Noise	<50 mV p-p
Rated Output (RO)	±5 VDC
Excitation (VDC or VAC)	11–26 VDC, 1 Watt
Connection	12 pin Binder Series #581 (09-0331-90-12)

MECHANICAL

Safe Overload	150% of RO
Zero Balance	±1% of RO
Material	Aluminum (Housing) Steel Alloy (Shaft)
IP Rating	IP40

TEMPERATURE

Operating Temperature	–13 to 176°F (–25 to 80°C)
Compensated Temperature	41 to 122°F (5 to 50°C)
Temperature Shift Zero	±0.01% of RO/°F (±0.02% of RO/°C)
Temperature Shift Span	±0.01% of RO/°F (±0.02% of RO/°C)

CALIBRATION

Calibration Test Excitation	12 VDC
Calibration (standard)	Certificate of Conformance
Calibration (available)	5-pt CW & CCW
Shunt Calibration Value	With sensor fully connected apply 11–26 VDC to Pins A & K to generate 5 VDC nom output

ENCODER

Output	Impulse (TTL)
Pulses per Revolution	2 × 360
Excitation	5 VDC, 40 mA max
Angle 1	Leading Pulse
Angle 2	Trailing Pulse (90°)

CONFORMITY

RoHS	2014/30/EU
CE	Declaration of Conformity

Model TRS705

WARNING: DO NOT CONNECT OR DISCONNECT WITH THE POWER ON.

TORQUE CONNECTIONS

PIN	COLOR	DESCRIPTION
C	Green	+ Voltage Output
D	White	- Voltage Output
E	Black	Ground
F	Red	Power Supply

ANGLE CONNECTOR CODES

PIN	COLOR	DESCRIPTION
B	Blue	Signal (Angle 1)
E	Black	Ground
G	Brown	Signal (Angle 2)
H	Orange	Power

SHUNT CAL CONNECTOR CODES

PIN	COLOR	DESCRIPTION
A	Yellow	Ground
K	Purple	Power

SHIELD CONNECTOR CODES

PIN	COLOR	DESCRIPTION
M	Braided	Shield connected to Chassis

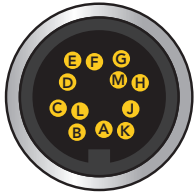

DIMENSIONS inches [mm]

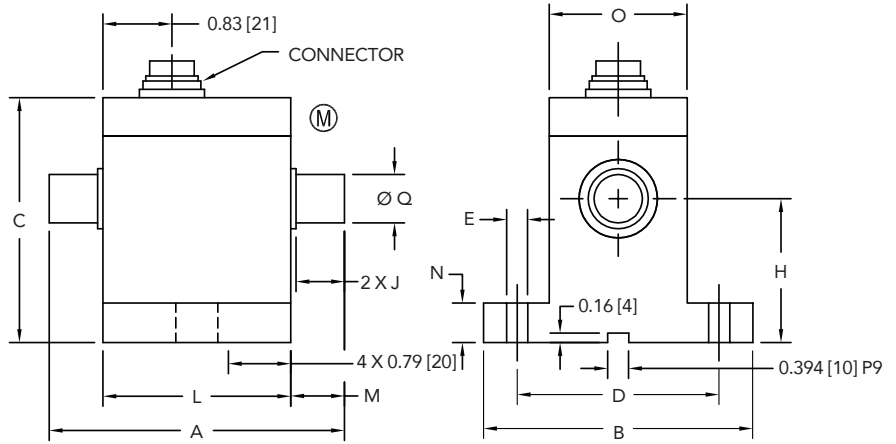

Ⓜ = MEASURING SIDE

** MAXIMUM LOAD ALLOWED. NOT FOR MEASUREMENT.

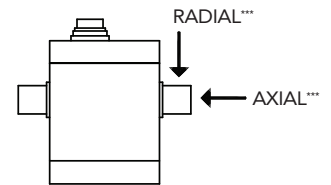

MASS MOMENT OF INERTIA (kg × cm²)

ITEM #	Measuring End	Drive End
FSH02562	0.0146	0.0147
FSH02563	0.0146	0.0147
FSH02564	0.015	0.015
FSH02565	0.015	0.015
FSH02566	0.062	0.061
FSH02567	0.064	0.063

CAPACITIES

ITEM #	Nm [in-lb]	∅ Q	A	B	C	D	E	H	J	L	M	N	O	** Max Axial Force lb [N]	** Max Radial Force lb [N]	Weight lb [kg]	Torsional Stiffness Nm/rad
FSH02562	1 [9]	0.394 [10] g6	3.54 [90]	2.28 [58]	3.27 [83]	1.77 [45]	0.28 [7]	1.77 [45]	0.59 [15]	2.28 [58]	0.63 [16]	0.47 [12]	1.10 [28]	4.5 [20]	3 [15]	1.1 [0.50]	317
FSH02563	2 [18]													11 [50]	5 [25]		317
FSH02564	5 [44]													22 [100]	11 [50]		855
FSH02565	10 [89]	0.669 [17] g6	4.17 [106]	3.35 [85]	4.02 [102]	2.36 [60]	0.35 [9]	2.48 [63]	0.87 [22]	2.32 [59]	0.91 [23]	0.59 [15]	1.50 [38]	33 [150]	11 [50]	2.2 [1.00]	855
FSH02566	20 [177]													33 [150]	33 [150]		4580
FSH02567	50 [443]													45 [200]	33 [150]		8190



RoHS



U.S. Manufacturer

Model TRS705

WARNING: DO NOT CONNECT OR DISCONNECT WITH THE POWER ON.

TORQUE CONNECTIONS

PIN	COLOR	DESCRIPTION
C	Green	+ Voltage Output
D	White	- Voltage Output
E	Black	Ground
F	Red	Power Supply

ANGLE CONNECTOR CODES

PIN	COLOR	DESCRIPTION
B	Blue	Signal (Angle 1)
E	Black	Ground
G	Brown	Signal (Angle 2)
H	Orange	Power

SHUNT CAL CONNECTOR CODES

PIN	COLOR	DESCRIPTION
A	Yellow	Ground
K	Purple	Power

SHIELD CONNECTOR CODES

PIN	COLOR	DESCRIPTION
M	Braided	Shield Sensor Body

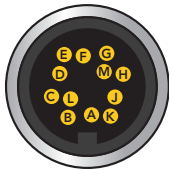

DIMENSIONS inches [mm]

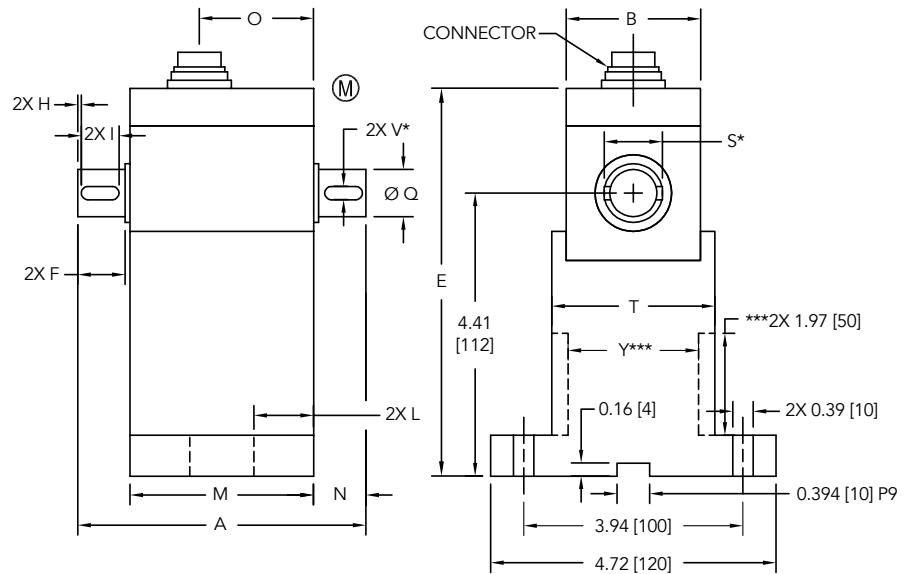

(M) = MEASURING SIDE

* FEATHER KEYWAYS COME PRE-INSTALLED.

** MAXIMUM LOAD ALLOWED. NOT FOR MEASUREMENT.

*** HIGHER CAPACITY UNITS HAVE STEP IN MIDDLE OF BASE.

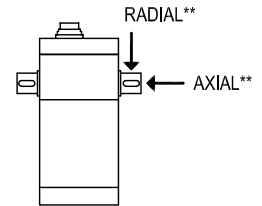

MASS MOMENT OF INERTIA (kg × cm²)

ITEM #	Measuring End	Drive End
FSH02568	0.665	0.605
FSH02569	0.68	0.62
FSH02570	3.2	2.63
FSH02571	3.21	2.67

CAPACITIES

ITEM #	Nm [in-lb]	Ø Q	A	B	E	F	H	I	L	M	N	O	S*	T	V*	Y***	** Max Axial Force lb [N]	** Max Radial Force lb [N]	Weight lb [kg]	Torsional Stiffness Nm/rad
FSH02568	100 [885]	1.102 [28] 96	4.92 [125]	2.28 [58]	6.26 [159]	1.06 [27]	0.08 [2]	0.87 [22]	0.79 [20]	2.52 [64]	1.20 [30.5]	1.57 [40]	1.34 [34]	2.68 [68]	0.315 [8] p9	-	90 [400]	56 [250]	5.2 [2.36]	28600
FSH02569	200 [1770]		90 [400]	67 [300]	45845															
FSH02570	500 [4425]	1.654 [42] 96	7.76 [197]	2.87 [73]	6.52 [165.5]	2.28 [58]	0.12 [3]	1.97 [50]	0.98 [25]	2.87 [73]	2.44 [62]	1.73 [44]	1.89 [48]	3.27 [83]	0.551 [14] p9	2.87 [73]	180 [400]	90 [400]	9.5 [430]	130000
FSH02571	1000 [8851]		225 [1000]	90 [400]	173600															

Drawing Number: FI1411-E

FUTEK reserves the right to modify its design and specifications without notice.

Please visit <http://www.futek.com/salesterms> for complete terms and conditions.

10 Thomas, Irvine, CA 92618 USA

Tel: (949) 465-0900

www.futek.com



RoHS



U.S. Manufacturer